

DOUBLE CARTRIDGE BASINS:

RECTANGULAR: Grate width 21-24"

Grate Length	Part Number	Basin Size	Filtered Flow Rate	Bypass Flow Rate	Debris Capacity
39-43"	SEVSB303	18"x36"	230gpm	1706gpm	3.2 cubic ft
44-47"	SEVSB302	18"x40"	230gpm	1795gpm	3.6 cubic ft
48-52"	SEVSB301	18"x44"	230gpm	1975gpm	4.0 cubic ft

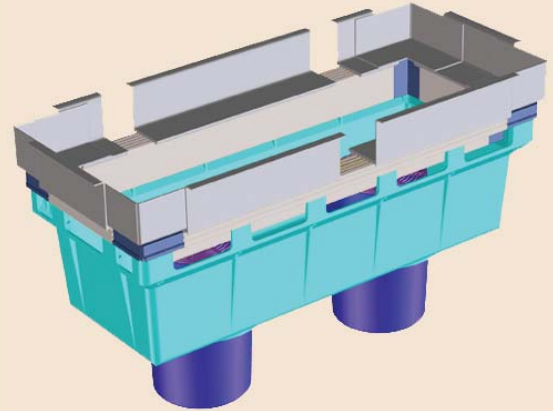

RECTANGULAR: Grate width 25-30"







Grate Length	Part Number	Basin Size	Filtered Flow Rate	Bypass Flow Rate	Debris Capacity
39-43"	SEVSB313	22"x36"	230gpm	1885gpm	4.0 cubic ft
44-47"	SEVSB312	22"x40"	230gpm	1975gpm	4.5 cubic ft
48-52"	SEVSB311	22"x44"	230gpm	2110gpm	5.0 cubic ft

RECTANGULAR: Grate width 31-36"

Grate Length	Part Number	Basin Size	Filtered Flow Rate	Bypass Flow Rate	Debris Capacity
39-43"	SEVSB333	28"x36"	230gpm	1885gpm	5.8 cubic ft
44-47"	SEVSB332	28"x40"	230gpm	1930gpm	6.4 cubic ft
48-52"	SEVSB331	28"x44"	230gpm	2110gpm	7.0 cubic ft

For ordering purposes, just add correct dash identifier for desired mounting flange type to P/N (e.g. SEVSB303 rectangular basin with a deep adjustable flange becomes: SEVSB303-F3). Desired filter cartridge P/N is to be specified separately.

MOUNTING FLANGE ASSEMBLY:

F1 Flat Adjustable	Designed for drop inlets with flat grate covers. Offers adjustment of up to 4" when installing in catch basin.	
F2 Flat Adjustable, Open Curb	Designed for combo curb drop inlets with flat grate covers. Includes rear deflector for redirecting flow entering along curb. Offers adjustment of up to 4" when installing in catch basin.	
F3 Deep Adjustable	Designed for drop inlets with grate covers that are not flat on the underside. Offers similar adjustment as the flat flange.	
F4 Deep Adjustable, with Locking Grate	Designed for drop inlets with grate covers that are not flat on the underside and have a locking mechanism.	
F5 Open Curb	Designed for combo drop/open curb inlets. Includes rear deflector for redirecting flow entering along curb.	
F6 Deep Adjustable, Open Curb, Locking Grate	Designed for combo drop/open curb inlets with grates that have a locking mechanism. Includes rear deflector for redirecting flow entering along curb.	

SINGLE CARTRIDGE BASINS:

RECTANGULAR: Grate width 21-24"

Grate Length	Part Number	Basin Size	Filtered Flow Rate	Bypass Flow Rate	Debris Capacity
27-31"	SEVSB306	18"x24"	115gpm	1167gpm	2.0 cubic ft
32-35"	SEVSB305	18"x28"	115gpm	1364gpm	2.4 cubic ft
36-38"	SEVSB304	18"x32"	115gpm	1436gpm	2.8 cubic ft

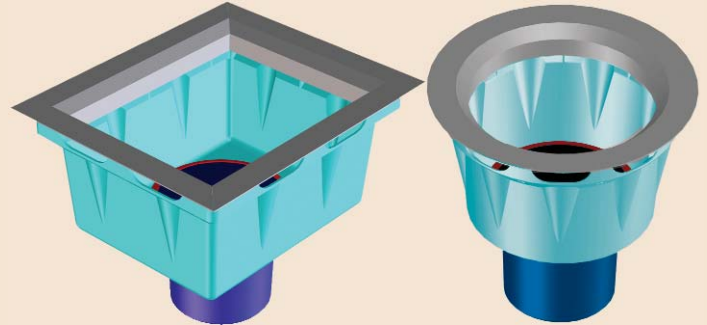

RECTANGULAR: Grate width 25-30"

Grate Length	Part Number	Basin Size	Filtered Flow Rate	Bypass Flow Rate	Debris Capacity
27-31"	SEVSB316	22"x24"	115gpm	1346gpm	2.5 cubic ft
32-35"	SEVSB315	22"x28"	115gpm	1481gpm	3.0 cubic ft
36-38"	SEVSB314	22"x32"	115gpm	1571gpm	3.6 cubic ft

ROUND: Grate diameter 24-30"

Grate Length	Part Number	Basin Size	Filtered Flow Rate	Bypass Flow Rate	Debris Capacity
Round	SEVSB341	19.5"dia.	115gpm	920gpm	1.5 cubic ft

SQUARE: Grate width 24-26"

Square	SEVSB342	19.5"dia.	115gpm	920gpm	1.5 cubic ft
--------	----------	-----------	--------	--------	--------------

For ordering purposes, just add correct dash identifier for desired mounting flange type to P/N (e.g. SEVSB303 rectangular basin with a deep adjustable flange becomes: SEVSB303-F3). Desired filter cartridge P/N is to be specified separately.

FILTER CARTRIDGES

Type	Part Number	Color Code	Target Pollutants	Flow Rate	Total Weight
Standard	SEVSC181	Red	Oil, grease, pathogens, metals	70-115gpm	14lbs
Microbe	SEVSC182	Yellow	Pathogens bacteria, oil	80-160gpm	4lbs
Hydrocarbons	SEVSC183	Blue	Fuel, oil grease	70-130gpm	4lbs
Heavy Metal	SEVSC184	Grey	Heavy metals, oil, pathogens	70-130gpm	4lbs
Mini-Standard	SEVSCS71	Green	Oil, pathogens	85-115gpm	8lbs

